



Safety Instructions – CGR – Zone 20/21



IECEX

Centurion Guided Radar HAWK CGR SERIES

IECEX Zone 20/21

Intrinsically Safe probe / Flameproof enclosure

IECEX TSA 14.0037X

Ex ia tb [ia Da] IIIC T85°C... T250°C Da Db

Tamb = -°C to +60°C**

IP 66, NEMA 4X

Equipment types:

CGR2 2 wire Centurion Guided Radar

CGR4 4 wire Centurion Guided Radar

Document No: SI0051

Doc ID: 3611

Version 1.3

08 August, 2018



NOTES:

Contents

1.	General	5
2.	Hazardous Areas	5
3.	Equipment Identification.....	6
4.	Dual Compartment Enclosure	7
5.	Putting Into Service.....	8
6.	Conditions of Safe Use	9
7.	Assembling and dismantling (Front & Rear covers only)	10
8.	Maintenance and Repair.....	11
9.	Installation and Wiring.....	11
10.	Adjustment	11
11.	Enclosure (LCD) Orientation.....	12
12.	Application Conditions	14
13.	List of IECEx certified equipment types:	17
14.	Wiring configuration drawings:	17
15.	Approval Standards:.....	17
16.	IECEx Certificate of Conformity:.....	17
17.	Manufacturer Contact Information	18
18.	CGR Part Structure	19



Flexi cable

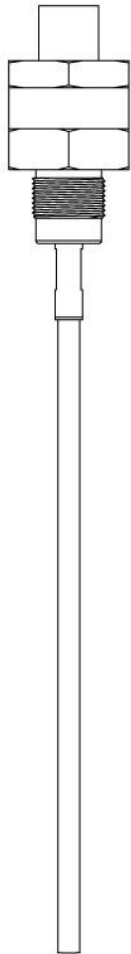

Rigid Probe

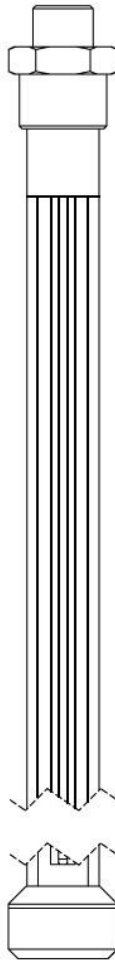

Coaxial Model 1



Coaxial Model 2

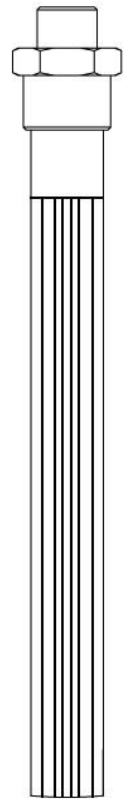

Coaxial Model 3

1. General

This document provides instructions for the safe installation of HAWK Centurion Guided Radar (CGR) series equipment, which is a process transmitter consisting of a sensing probe attached to an electronic control amplifier.

HAWK CGR series equipment is a continuous Level and Interface Measurement unit. It uses low power high frequency RF pulses based on the TDR principle to measure liquids and solids in contact with the sensing probe.

These units are usually mounted directly at the level measurement point – at the top of a storage vessel – with the probe directed downwards in contact with the material product surface. Refer to **Installation Guide** in the **User Manual**.

HAWK CGR units are available with either 2 wire loop power or 4 wire option. User interface controls shall be accessed only when an explosive atmosphere is not present.

2. Hazardous Areas

The HAWK CGR is certified under IECEx standards for installation in hazardous dust locations according to IECEx Certificate of Conformity IECEx TSA 14.0037A. IECEx certified equipment is recognised in most countries around the world.

The HAWK CGR enclosure has a dual compartment with segregated Ex d and cable connection sections. The amplifier is located inside the dust-ignition proof (Ex tb) compartment and the user connections are terminated in the rear compartment, whereas the sensing probe is protected using the Intrinsic Safe (Ex ia) method, where the energy supplied from the amplifier is limited to a safe level according to the standards. If sensing probe is mounted across the boundary of zone, it acts as a seal across the partition wall. Probe Seal comprises of SS316L, PEEK, PTFE+GF25 and O-rings (NBR, Viton, EPDM, Silicone and FFKM (MARKEZ) etc).

When HAWK CGR equipment is installed and mounted in hazardous areas, these User Manual, Safety and Operating Instructions, the general Ex installation regulations and the general installation regulations for electrical equipment must all be observed.

Installation of Ex instruments should only be made by suitably trained personnel.

Zone 20/21 areas

The CGR sensing probe can be installed into hazardous zone 20 in dust groups IIIC, IIIB or IIIA, whereas the amplifier enclosure can only be installed into zones 21.

Zone 21 & Zone 22 areas

Both sensing probe and amplifier enclosure can be installed into hazardous zones 21 or 22, in dust groups IIIC, IIIB or IIIA.

3. Equipment Identification

An image of the IECEx marking nameplate is shown below.

(1) Product Name

(2) Part Number (*Refer Sect.18 – Part Structure and Sect.12.f. – Application Condition/Temperature for max permitted process temperature and/or temperature class*)

(3) Serial Number

(4) Manufacture Date

(5) Input supply voltage range

(6) Maximum value of U_m applied to non intrinsically safe circuits

(7) Output current and communications protocol

(8) Ingress Protection rating

(9) Hazardous Locations Marking codes

(10) Ambient Temperature Range (*** denotes lower temperature range depending on O-ring material*)

O-ring Material (<i>refer coding (h) in part structure – Section 18</i>)	Ambient Temperature Range
NBR, VITON, EPDM, SILICONE	-40°C to +60°C
MARKEZ (FFKM)	-10°C to +60°C

(11) IECEx Certificate of Conformity number

(12) Electrical Entry Thread Type

(13) Manufacturer Logo and Name

(14) Manufacturer Web Address

(15) Manufacturer country

(16) Warning symbol and Symbol for Reference to written instructions

(17) Warning message

(18) Quick Reference code

(19) FCC and CE marking symbols

(20) SIL Certification and HART Registered Symbols

4. Dual Compartment Enclosure

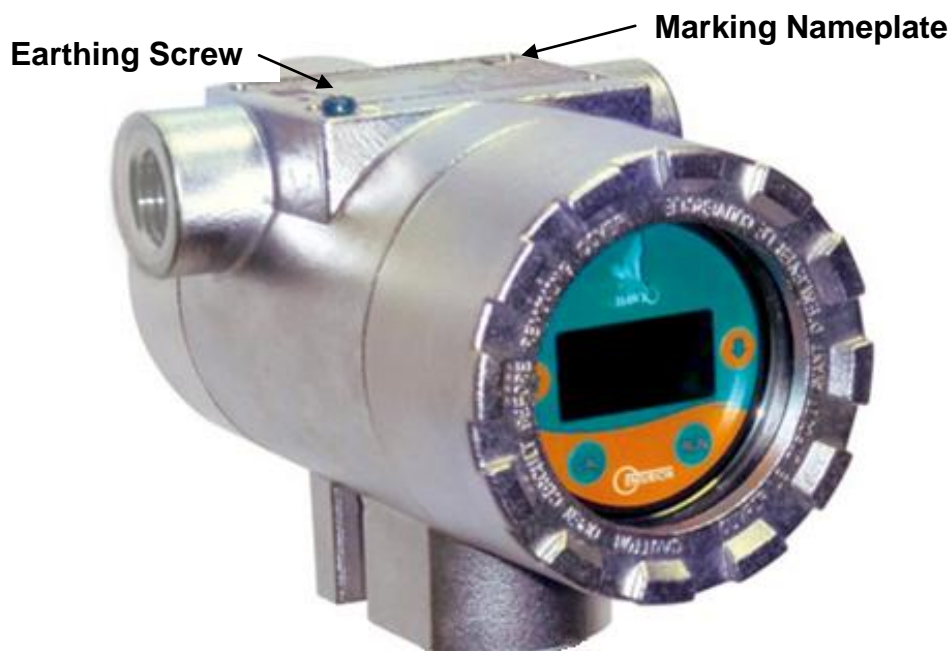
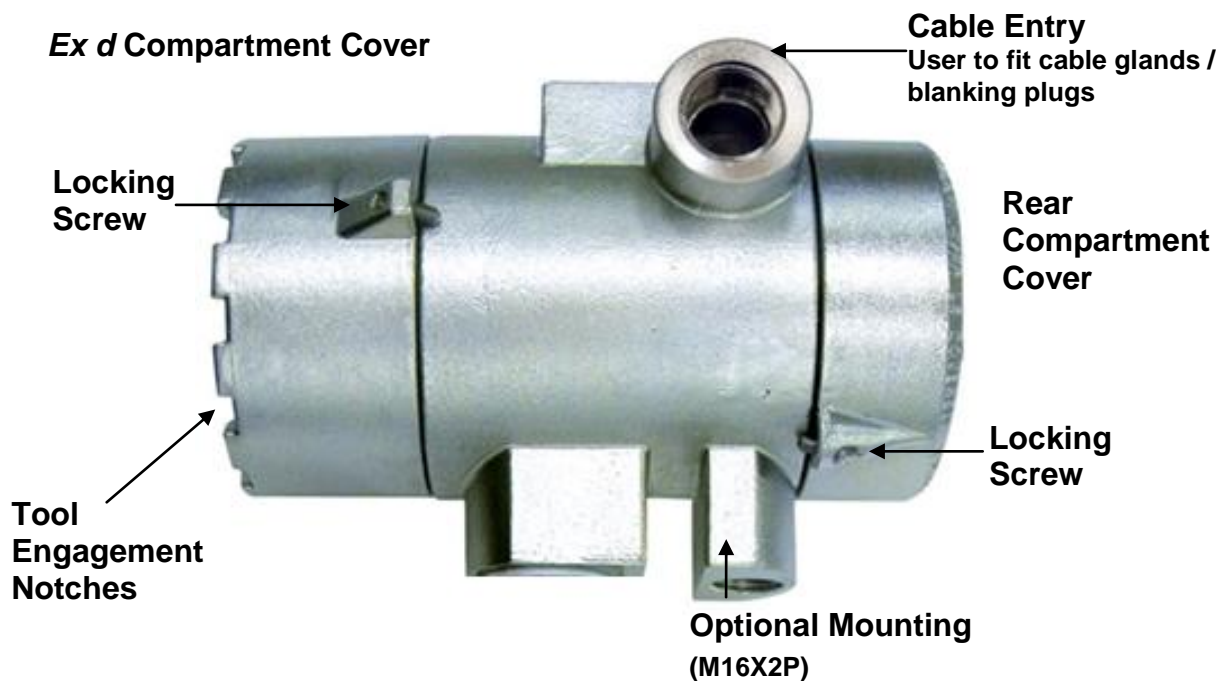

5. Putting Into Service

To put a HAWK CGR unit safely into service, the following steps must be taken:

- a) Follow the instructions in **Typical Installations** and **Installation Guide**.
- b) All CGR series models are fitted with an Ex tb Barrier Conduit Fitting between enclosure port and the sensing probe. This conduit fitting is factory fitted and must not be tampered or unscrewed or modified. **Install the unit from the Process Fitting only** (refer Section 11)
Do not rotate by grasping the enclosure.
- c) Cables coming into the CGR unit shall be sealed using certified Ex tD cable glands and all unused cable entry points shall be sealed using certified Ex tD blanking plugs. **These cable glands and blanking plugs should be certified to same or higher EPL and IP rating as CGR unit and fitted by the qualified technician.**
- d) Correct wiring.

Follow the instructions in the **Wiring Diagram** sections. Wiring should be in accordance with relevant installation standards for hazardous area equipment or other local codes of practice.

- e) Safe temperature

When installed in hazardous area dust application, the ambient temperature must not exceed the temperature limits shown on the marking nameplate (refer Section 3).

Refer Application Conditions (Section 12. f) for the maximum permissible process temperatures for the CGR unit depending on the Probe model and O-ring material. Temperatures should not exceed those specified in the table.

- f) Safe Pressure.

Process pressure subjected to the sensing probe in EPL Da and Db hazardous areas must be between the limits of 80 to 110 kPa. (0.8 bar to 1.1 bar)

- g) Safe power supply.

Power supply values must be according to those stated in the **Specifications**.

- h) Probe Tensile Force (Flexi cable models)

Probe Type	Tensile Force
Stainless steel rope, 4 mm @ 20°C	5 kN
Stainless steel rope, 6 mm @ 20°C	10 kN
Stainless steel rope, 8 mm @ 20°C	40 kN

- i) Probe Lateral Force (Rigid and Coaxial models)

Probe Type	Lateral Force
Rod, 4 mm	1 Nm
Rod, 6 mm	3 Nm
Rod, 8 mm	8 Nm

- j) Do not put into service where there is a possibility of contact with acetic acid.

6. Conditions of Safe Use

The instructions for safe use of the CGR unit are as follows:

- a) The CGR equipment must put into service safely. (refer **Putting Into Service**, Section 5).
- b) Warning: **Do not open the enclosure when an explosive atmosphere is present.**
- c) The User Manual must be read and understood by any person involved with this unit.
- d) Environment and installation conditions should be checked regularly.
- e) When used in hazardous area dust applications with various process temperatures, selection of materials, use of extensions and ambient temperature ranges must be in accordance with table shown under Section 12. f) and part structure under Section 18.
- f) When opening the cover of any CGR unit, prevent dust, liquids or chemical substances from getting inside the unit. Do not leave any cover open in rain or snow conditions.
- g) The LCD display on the CGR series transmitter is visible through the clear window.
- h) Before making any wiring or hardware configuration changes, it is important to disconnect power from the equipment.
- i) The enclosure has a non-conducting coating and may generate an ignition-capable level of electrostatic charge under certain extreme conditions. The user shall ensure that the equipment is not installed in a location where it may be subjected to external conditions (such as high-pressure steam) which might cause a build-up of electrostatic charges on non-conducting surfaces. Additionally, cleaning of the equipment should be done only with a damp cloth.
- j) Hawk CGR units must not be installed in areas with direct and continuous vibration.

7. Assembling and dismantling (Front & Rear covers only)

Only the front and rear covers of the Ex tb enclosure are able to be removed in CGR series models, and only if an explosive atmosphere is not present.

It is absolutely essential that this procedure is not done if an explosive atmosphere is present.

The user interface controls and the rear terminal cover are able to be accessed by loosening a set screw then unscrewing the top cover with the aid of a suitable hand tool which does not cause any damage to the equipment.

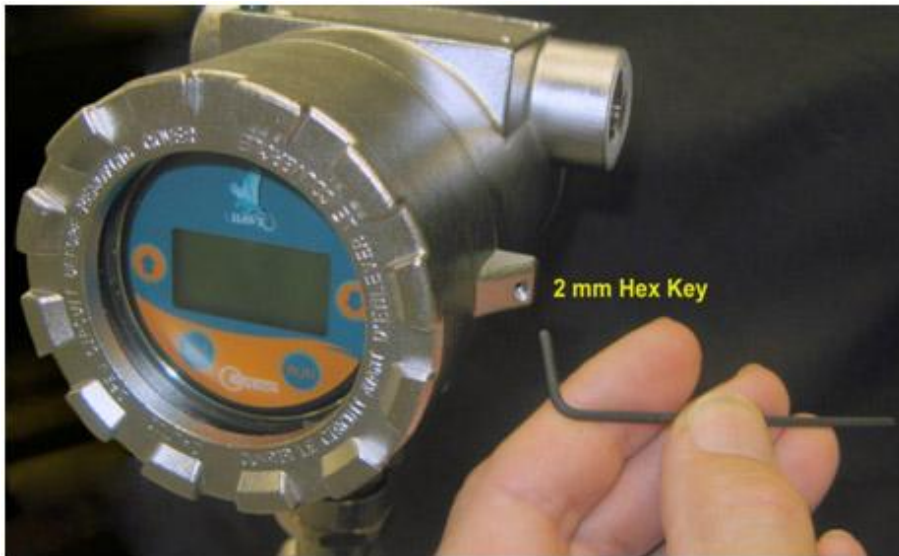

WARNING !
DO NOT OPEN
WHEN AN
EXPLOSIVE
ATMOSPHERE
IS PRESENT



8. Maintenance and Repair

For Maintenance, refer the **User Manual**

For Repair, please return the product/goods to the factory

9. Installation and Wiring

Carefully follow **Typical Installations, Installation Guide** and **Wiring Diagram** section in the User Manual. Follow all points listed in **Putting Into Service**, above.

Tighten at process fitting (refer Section 11)

Wiring should be in accordance with relevant installation standards for hazardous area equipment (eg, IEC 60079-14) and any other local codes of practice.

10. Adjustment

a) Software Adjustment:

For software adjustment of CGR unit parameter adjustment and data entry, refer to instructions in **Entering Data**, and all of the **Setup** sections.

If *GosHawk II* software is to be used for parameter adjustment and data entering from a lap-top computer, etc, the user must first read and fully understand the information in the *GosHawk II Manual* either supplied with the equipment or downloaded free from the HAWK web-site: <http://www.hawkmeasure.com>

Basic parameter adjustments to CGR units with HART communications option can be remotely adjusted using a standard HART calibrator.

Note: Computing equipment and mobile phones should not be used in a hazardous area.

b) Hardware Adjustment:



The only hardware adjustment allowed is shortening of the Hawk supplied Flexible and Rigid probe length to suit the measuring span on site.

Refer to user manual for more information

11. Enclosure (LCD) Orientation

The Ex tb Barrier Conduit Fitting which couples the sensing probe to the flameproof enclosure provides a critical sealing function for the enclosure. Internal wires are passed through this fitting and the high integrity seal. This fitting incorporates a Union Joint which is designed to rotate. However this rotation is limited to one-time adjustment of Display orientation after installation on site, as shown below:

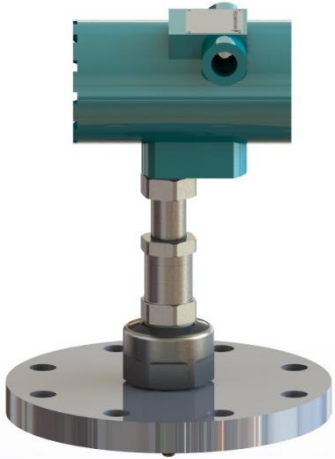
HAWK Barrier Conduit Fitting

<p>ONLY one 36mm spanner applied to the Hex of Conduit Fitting to rotate enclosure to desired orientation as allowed. <i>DO NOT</i> hold the enclosure during this procedure.</p>		
		
<p>As Installed, but LCD display not visible.</p>	<p>Rotation at Union Barrier Conduit Fitting</p> <p>Max 180° allowable one-time rotation in either direction, following the shortest arc</p>	<p>Desired Orientation.</p>

Note:

- Rotation beyond these strict limits can damage the internal cables
- Ensure Enclosure follows the spanner rotation and assembly integrity is not compromised

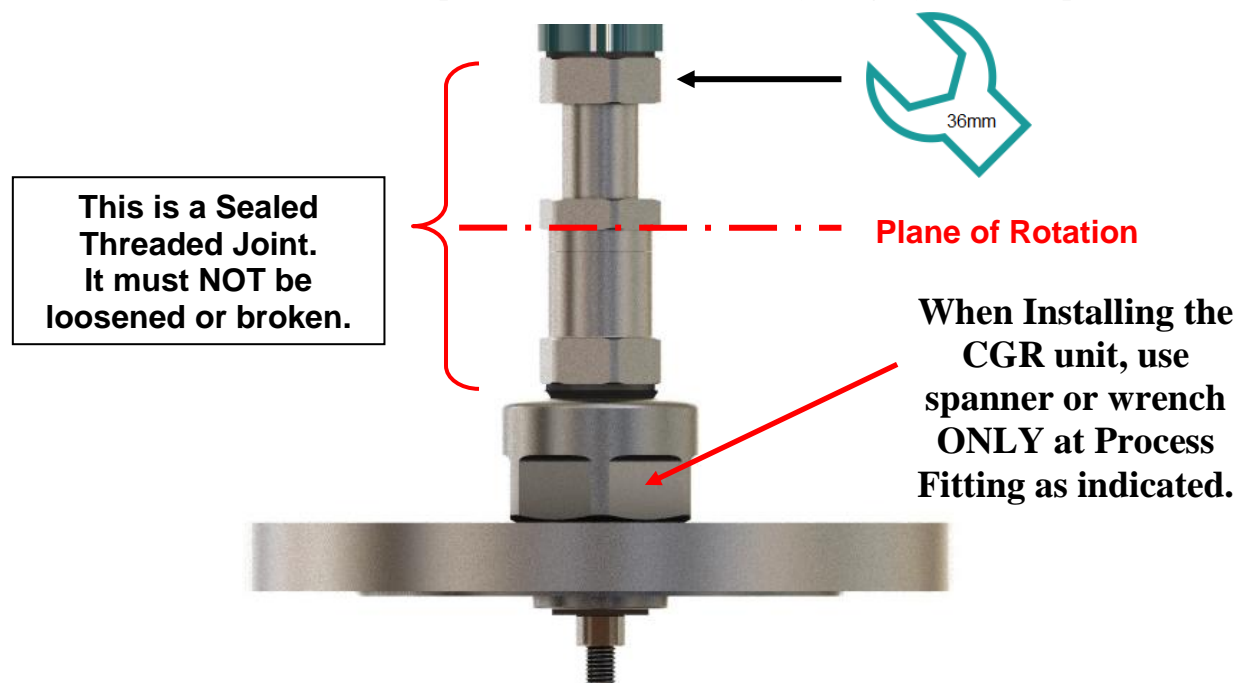

HAWKE (SB474) Barrier Conduit Fitting (optional)

ONLY one 36mm spanner applied to the Hex of Union Joint to rotate enclosure to desired orientation as allowed. *DO NOT* hold the enclosure during this procedure.

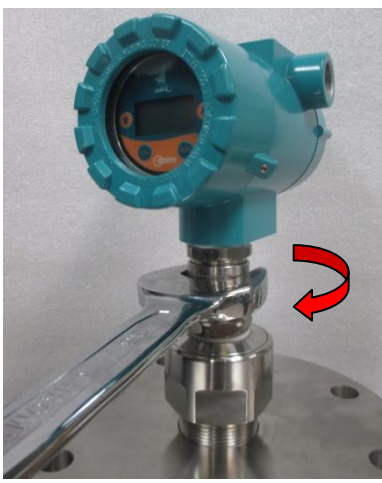
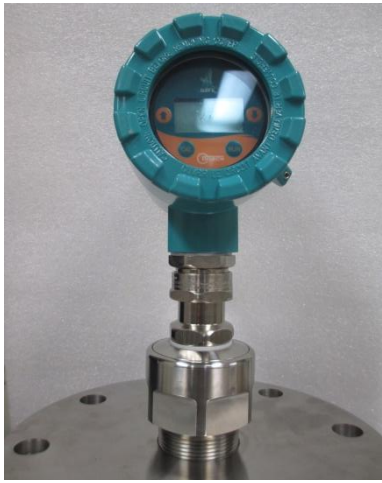
		
<p>As Installed, but LCD display not visible.</p>	<p>Rotation at Union Joint Max 180° allowable one-time rotation in either direction.</p>	<p>Desired Orientation.</p>

Note:

- **Rotation beyond these strict limits can damage the internal cables**
- **Ensure Enclosure follows the spanner rotation and assembly integrity is not compromised**

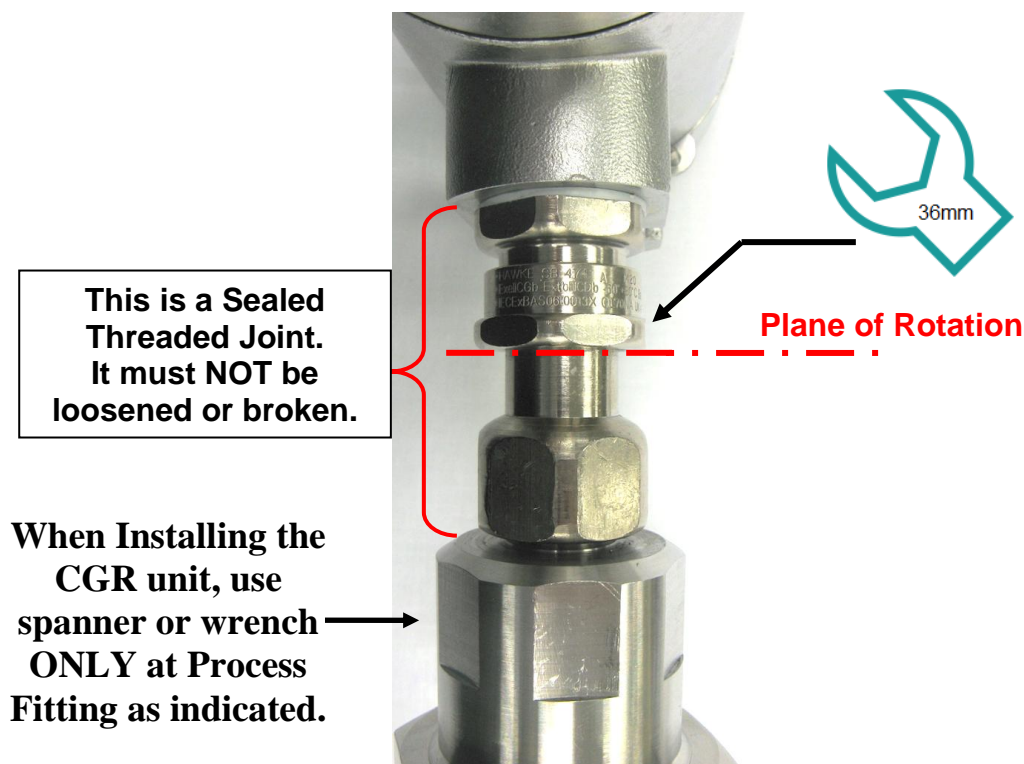

12. Application Conditions

a) Voltage Supply:

Must be according to the voltage supplies given in **Specifications**

$U = 14...28 \text{ V DC}$ Peak voltage that can be applied to the equipment without invalidating the type of protection.

$U_m = 250 \text{ V AC}$ Maximum voltage that can be applied to the non intrinsically safe connection of associated equipment without invalidating the type of protection.

b) Cable Connection:

Cables and wiring must be installed according to the appropriate standards.

Cable connection compartment must be sealed using appropriate glands and blanking plugs (**Refer to Section 5.c of Putting Into Service**).

If extending the cable, it must be protected in a junction box and terminated in an enclosure suitable for the environment.

Refer to Wiring Diagrams.

c) Earthing:

HAWK CGR equipment should be earthed via a resistance of less than 1 MegOhm to the Earthing Screw to reduce the possibility of electrostatic discharge.

d) Electrostatic Discharge:

Warning: Avoid Electrostatic Discharge

Do not rub the non-metallic surface of this equipment with a dry cloth.

Do not install this equipment in areas where nonconductive materials could flow onto the enclosure surface.

e) Industrial Conditions:

This equipment is designed for use in normal industrial conditions relating to humidity, vibration, etc. If the user intends to operate the equipment in more severe environmental conditions, the manufacturer or local distributor should be consulted for advice.

f) Max Surface Temperature, Process Temperature Range and Pressure

Maximum Surface Temperature	Process Temperature Range	Barrier Conduit Fitting Type	Requirement for extension	Probe Model	O-ring material	Part code for letters “h” and “i”
T85 °C	-40 °C to +80 °C	Hawk Barrier Conduit Fitting with Sealing Compound	With or without extension	X8 X6 X4	NBR	B1 or BA
					EPDM	E1 or EA
		Or			VITON	V1 or VA
		Hawke SB474 Barrier Fitting			SILICON	S1 or SA
T85 °C	-10 °C to +80 °C			X6 X4	MARKEZ (FFKM)	M1 or MA
T100 °C	-40 °C to +100 °C	Hawk Barrier Conduit Fitting with Sealing Compound	With or without extension	X8 X6 X4	EPDM	E2 or EB
		Hawke SB474 Barrier Fitting	Minimum Ø34x50 mm extension		VITON	V2 or VB
		Hawk Barrier Conduit Fitting with Sealing Compound	With or without extension	X8 X4	SILICON	S2 or SB
		Hawke SB474 Barrier Fitting	Minimum Ø34x50 mm extension			
T100 °C	-10 °C to +100 °C	Hawk Barrier Conduit Fitting with Sealing Compound	With or without extension	X6 X4	MARKEZ (FFKM)	M2 or MB
		Hawke SB474 Barrier Fitting	Minimum Ø34x50 mm extension			
T135 °C	-40 °C to +130 °C	Hawk Barrier Conduit Fitting with Sealing Compound	With or without extension	X8 X6 X4	EPDM	E3 or EC
		Hawke SB474 Barrier Fitting	Minimum Ø34x50 mm extension		VITON	V3 or VC
		Hawk Barrier Conduit Fitting with Sealing Compound	With or without extension	X8 X4	SILICON	S3 or SC
		Hawke SB474 Barrier Fitting	Minimum Ø34x50 mm extension			
T135 °C	-10 °C to +130 °C	Hawk Barrier Conduit Fitting with Sealing Compound	With or without extension	X6 X4	MARKEZ (FFKM)	M3 or MC
		Hawke SB474 Barrier Fitting	Minimum Ø34x50 mm extension			

T150 °C	-40 °C to +150 °C	Hawk Barrier Conduit Fitting with Sealing Compound	Minimum Ø34x50 mm extension	X6 X4	VITON	V4 or VD
		Hawke SB474 Barrier Fitting	Minimum Ø34x95 mm extension			
T150 °C	-10 °C to +150 °C	Hawk Barrier Conduit Fitting with Sealing Compound	Minimum Ø34x50 mm extension	X6 X4	MARKEZ (FFKM)	M4 or MD
		Hawke SB474 Barrier Fitting	Minimum Ø34x95 mm extension			
T200 °C	-10 °C to +200 °C	Hawk Barrier Conduit Fitting with Sealing Compound	Minimum Ø34x50 mm extension	X6 X4	MARKEZ (FFKM)	M5 or ME
		Hawke SB474 Barrier Fitting	Minimum Ø34x95 mm extension			
T250 °C	-5 °C to +250 °C	Hawk Barrier Conduit Fitting with Sealing Compound	Minimum Ø34x50 mm extension	X6 X4	MARKEZ (FFKM)	M6 or MF
		Hawke SB474 Barrier Fitting	Minimum Ø34x95 mm extension			

Note:

1. O-ring selection also depends on O-ring material suitability with respect to process medium
2. Ambient Temperature Range is dependent on O-ring material (refer Section 3)

13. List of IECEx certified equipment types:

2 wire Centurion Guided Radar – CGR2 series
4 wire Centurion Guided Radar – CGR4 series

Probe, Flange and Accessory selection in any combination

14. Wiring configuration drawings:

Refer to **Wiring Diagrams**

Note: All equipment in Hazardous Areas must have appropriate certification.

15. Approval Standards:

IEC 60079-0:2011, Edition 6.0	Explosive Atmospheres – Equipment - General Requirements.
IEC 60079-1:2014, Edition 7.0	Equipment protection by flameproof enclosures ‘d’.
IEC 60079-11:2011, Edition 6.0	Equipment protection by intrinsic safety ‘i’.
IEC 60079-26:2014, Edition 3.0	Explosive Atmospheres – Equipment with EPL Ga.
IEC 60079-31:2013, Edition 2.0	Equipment dust ignition protection by enclosure "t"

These standards specify test requirements at standard temperature, pressure and oxygen content. Additional consideration and/or testing may be required for equipment operating outside these limits.

16. IECEx Certificate of Conformity:

IECEx Certificate of Conformity IECEx TSA 14.0037X can be accessed directly on line using the following hyperlink ...

<http://iecex.iec.ch/iecex/iecexweb.nsf/certificatesAjax/IECEX TSA 14.0037X issue No. 3?opendocument>

or go to <http://www.iecex.com/>

select ‘View Certificates & Licenses’

then click the ‘Certified Equipment’ box

then enter IECEx TSA 14.0037X

and click the ‘View certificate’ box to begin the search.

17. Manufacturer Contact Information

Hawk Measurement Systems

Head Office

15-17 Maurice Court, Nunawading, Melbourne VIC 3131, Australia

PO Box 3230, Nunawading, Melbourne VIC 3131, Australia

Ph: +61 (0)3 9873 4750

Fax: + 61 (0)3 9873 4538

Email: info@hawk.com.au

Support: techsupport@hawk.com.au

Web: <http://www.hawkmeasure.com>

Hawk Measurement

Corporate and Sales Office

96 Glenn Street

Lawrence, MA 01843, USA

Ph: +1 978 304 3000 / +1 888 429 5538

Fax: +1 978 304 1462

Email: info@hawkmeasure.com

Web: <http://www.hawkmeasure.com>

18. CGR Part Structure

CGR	a	b	c	d	eee	f	gggg	h	i	j	kk	llll	(m)
													(m) OEM Company Code
													(llll) Probe length (in cms)
													(kk) Approvals
													kk = Approval Coding
													1D: Ex ia/db [ia Ga] IIC T6...T2 Ga/Gb Tamb -**°C to 60°C
													2D: Ex ia tb [ia Da] IIIC T85°C... T250°C Da Db Tamb -**°C to +60°C
													(j) Process Pressure
													j = 1 – 9 Process Pressure coding
													(i) Temperature Class / Max Process Temperature / Min Enclosure Extension
													i = 1 – 9 or A – Z Temp Class / Max Process Temp / Min Enclosure Ext coding
													1: Temp Class: T6 / Max Process Temp: +80°C / 0mm Extension
													2: Temp Class: T5 / Max Process Temp: +100°C / 0mm Extension
													3: Temp Class: T4 / Max Process Temp: +130°C / 0mm Extension
													4: Temp Class: T3 / Max Process Temp: +150°C / 50mm Extension
													5: Temp Class: T2 / Max Process Temp: +200°C / 50mm Extension
													6: Temp Class: T2 / Max Process Temp: +250°C / 50mm Extension
													A: Temp Class: T6 / Max Process Temp: +80°C / 500mm Extension
													B: Temp Class: T5 / Max Process Temp: +100°C / 500mm Extension
													C: Temp Class: T4 / Max Process Temp: +130°C / 500mm Extension
													D: Temp Class: T3 / Max Process Temp: +150°C / 500mm Extension
													E: Temp Class: T2 / Max Process Temp: +200°C / 500mm Extension
													F: Temp Class: T2 / Max Process Temp: +250°C / 500mm Extension
													J: Temp Class: T3 / Max Process Temp: +150°C / 90° Orientation
													(h) Process O-ring Seal / Rated Temperature
													B: NBR / -40°C to +80°C
													E: EPDM / -40°C to +130°C
													S: SILICONE / -40°C to +130°C
													V: FKM (VITON) / -40°C to +150°C
													M: FFKM (MARKEZ) / -10°C to +200°C / -5°C to +250°C
													(gggg) Mounting
													gggg = Mounting option coding for threads and flanges
													(f) Probe Variant/material
													f = A – Z probe material coding
													(eee) Probe Type
													AXX: Flexible Probe ; where X = 0.1 to 70mm diameter
													BXX: Rigid Probe ; where X = 0.1 to 70mm diameter
													CXX: Coaxial Probe ; where X = 0.1 to 70mm diameter
													DXX: Dual Probe ; where X = 0.1 to 70mm diameter
													EXX: Parallel Rigid Probe ; where X = 0.1 to 70mm diameter
													FXX: Parallel Flexible Probe ; where X = 0.1 to 70mm diameter
													JXX: Detached Flexible Probe; where X = 0.1 to 70mm diameter
													KXX: Detached Rigid Probe; where X = 0.1 to 70mm diameter
													(d) Gland Entry
													1: ½" NPT Cable Gland entry
													2: ¾" NPT Cable Gland entry
													3: M20x1.5 Cable Gland entry
													4: M25x1.5 Cable Gland entry
													5-9: Other Sizes
													(c) Housing
													Housing material code (0-5)
													(b) Communication
													B = communication option from A – Z
													(a) Model Type
													A = 1-9 or A-Z for number of wires and/or software variation for CGR

Technical data is subject to change without notice.
Images shown may differ from equipment supplied.